



AARTOS™ DDS MOBILE AND STATIONARY JAMMING SYSTEMS

**MJ** SERIES

**FJ** SERIES

**SJ** SERIES



 DETECT

 LOCALIZE

 COUNTER



**SJ 240 SJ 800**

Seamless frequency jamming from 400 MHz to 6 GHz with a 360° coverage and the highest range in our lineup.



**FU 360**

The stationary FJ series cover 360° with a range of up to 3 km and up to 15 frequency bands.



**MJ 170**

The mobile 6-band jammer is based on the MJ-40 with extended range and output power including a remote control and customizable bands.



**MJ 40**

This handheld UAV jammer is a potent and portable drone jamming system with 2h battery life and customizable frequency bands.

<b>Typ. Range</b>	▶ 4 km / 10 km	3 km	3-4 km	2 km
<b>Antenna(s)</b>	▶ 8 (directional)	2/4 (directional)	1 (directional)	1 (directional)
<b>Sectors</b>	▶ 8	2/4	1	1
<b>Bands</b>	▶ All bands up to 6 GHz	Up to 15	6	4
<b>Output Power</b>	▶ 240W 800W	180W / 360W	170W	40W





## SJ SERIES

Our AARTOS™ DDS programmable jammer delivers a gapless coverage from 400 MHz to 6 GHz with an effective jamming range of 10 km.

With its directional antennas it is able to cover all commercial and military drones up to 6 GHz and can counter them with a freely adjustable output power of 30W per sector (upgradable to 100W).

The AARTOS™ CMS (Countermeasure Solutions) can only be sold to entities with proper government approval for the deployment of jammers. For more information, contact us at [mail@aaronia.de](mailto:mail@aaronia.de).



## FJ SERIES

By extending the AARTOS™ DDS to include our stationary jammer with a jamming range of up to 3 km, it creates a system that can reliably and quickly locate and neutralize threats.

With its directional and omnidirectional antennas and a maximum output power of 360W the jammer is capable of countering drones within the most common frequency bands (430 MHz, 1.6 GHz, 2.4 GHz and 5.8 GHz, additional bands on demand).

As with all of our jammers, the interference created is extremely selective, in order to make sure other RF channels are not impaired. In addition, the jammer is directional, and will only jam signals in the direction of the incoming UAV.



## MJ SERIES

The mobile UAV jammers are a potent and portable drone jamming system, featuring up to 170W output power and an impressive 4 km range. Covering four to six frequency bands, it ensures adaptability to diverse unmanned aerial vehicles.

With a two-hour battery life, the device provides a reliable and portable solution for countering potential drone threats. Its standout feature is the highest coverage among commercial models, making it a valuable tool for security and defense applications.

Moreover, the device is customizable on demand, allowing users to tailor its specifications for specific operational needs, enhancing its flexibility and utility in various scenarios.





The SJ Jamming Series is an advanced and versatile device, designed to offer comprehensive frequency coverage and smart jamming capabilities. It stands out with its ability to program an unlimited number of channels or bands across the entire frequency spectrum, providing gapless coverage from 400 MHz to 6 GHz. This makes it exceptionally effective against both commercial and military drones.

One of its key features is the impressive operational range of up to 10 kilometers coupled with 360-degree.

This jammer is not only powerful but also customizable with either

omnidirectional or vehicle-integrated versions upon request. Additionally, customers can choose between different output power versions, either 30 W or 100 W per sector, and the device is available in 4 or 8 sector versions.

With no moving parts and an IP 65 rating, it guarantees a high level of protection against dust and water, making it suitable for a variety of environments. Despite its robust capabilities, the jammer remains relatively portable and can be operated in extreme temperature conditions, ranging from -20° C to +60° C.



## SJ<sup>240</sup>

## SJ<sup>800</sup>

SJ240-4

SJ240-8

SJ800-4

SJ800-8

Typ. Range ▶	4 km	4 km	10 km	10 km
Antenna(s) ▶	8x 45° directional	8x 45° directional	8x 45° directional	8x 45° directional
Simultaneous active sectors ▶	4	8	4	8
Frequency range ▶	400 MHz to 6 GHz	400 MHz to 6 GHz	400 MHz to 6 GHz	400 MHz to 6 GHz
Maximum output power ▶	120W	240W	400W	800W
Sector output power ▶	30W	30W	100W	100W



Active 45° sector with frequencies automatically detected in real-time

Jamming system is armed and actively jamming the selected sectors and detected frequencies

Inactive 45° sector with default pre-configured frequency bands

Standard SJ series come with 3 freely selectable frequency bands / sector (more on demand)

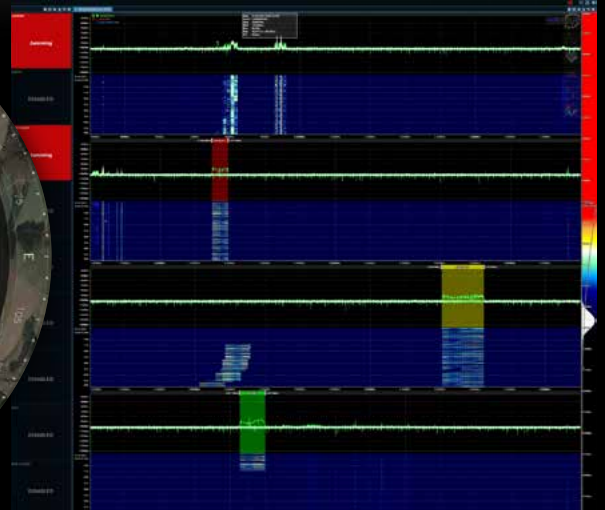



### 360° with 4 active sensors

The 4-sector jammer has the ability to jam in 4 directions simultaneously. The sectors are connected in pairs, and one sector of each pair can be switched on. For example, it would be possible to jam 45° in all 4 directions at the same time or, by adjusting the configuration/routing switch, block 0° to 180° (sector 1-4) simultaneously.

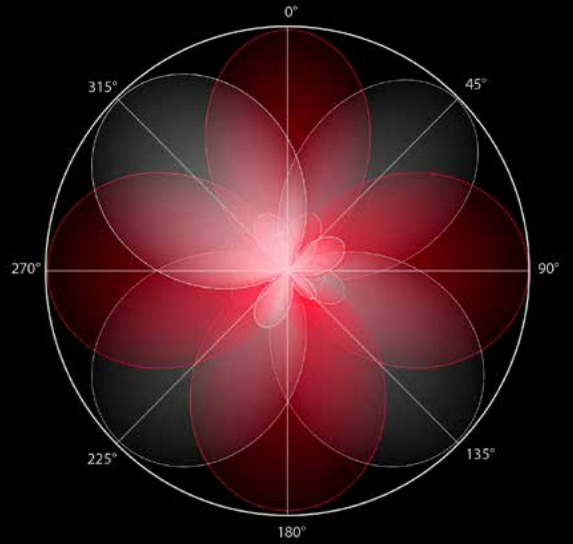
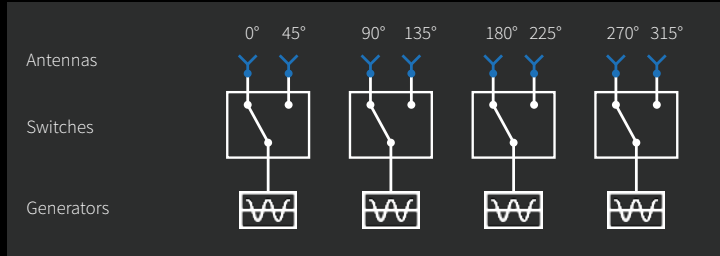

### 360° with ALL sensors active

With the 8-sector jammer, it is possible to jam the full 360° simultaneously. This is the most effective solution for securing critical infrastructures where multiple threats may enter an area at the same time (i.e. nuclear power plants, airports, borders etc.).

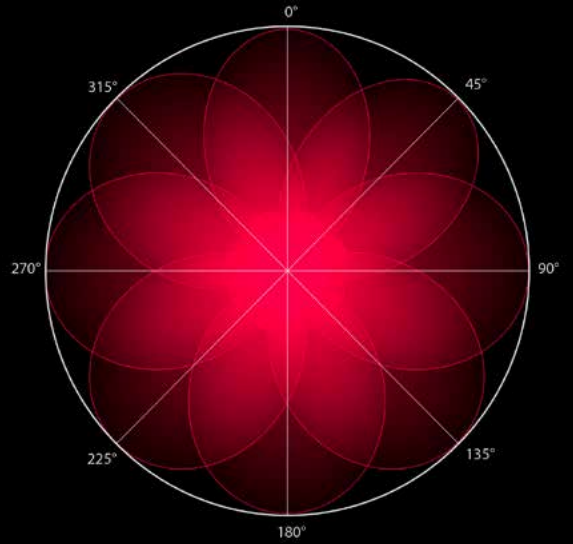
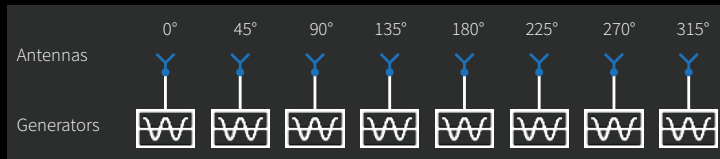

### Antenna Patterns

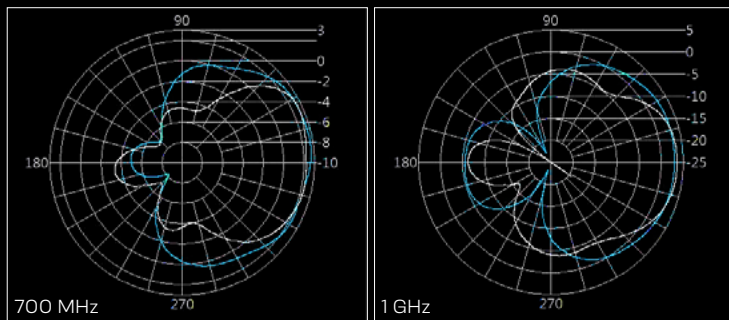

### Antenna Gain

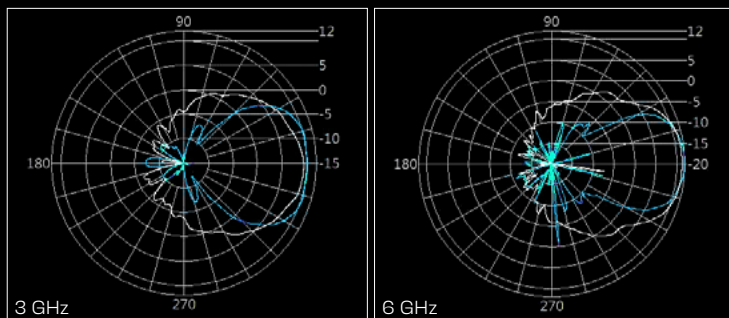
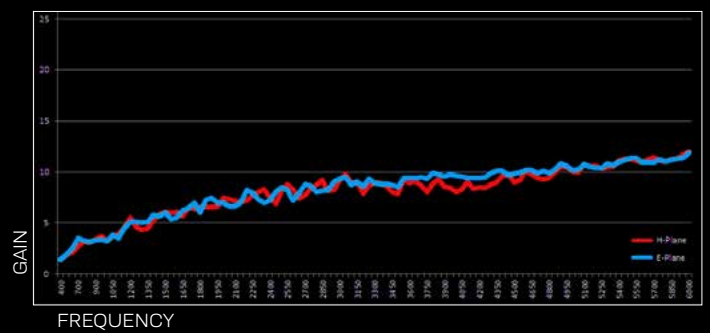

### Antenna Factor

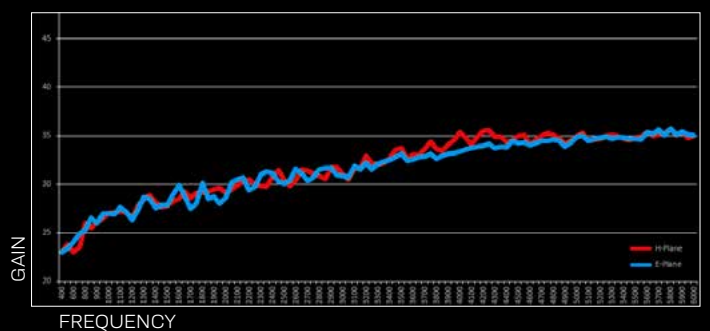



The "FJ Series" Fixed Bands Sector Jammer is a robust and versatile jamming device with several notable features that set it apart in the commercial market.

Designed for effectiveness and efficiency, it offers a substantial jamming range of up to 8 kilometers, making it suitable for a variety of operational scenarios.

One of its key strengths lies in its flexibility – it can handle up to 15 selectable frequency

bands, providing a wide scope of interference capabilities. A standout feature of the FJ Series is its ultra-sharp signal purity, which ensures precise jamming without unnecessary spill-over into non-target frequencies. This precision is backed by a potent output power of up to 360 watts. The device covers the largest frequency range among all commercial models, highlighting its versatility and adaptability in different environments.

Users can choose between corner jammer models, which provide a focused 180° coverage, and omni-jammer models that offer a comprehensive 360° coverage, depending on their specific needs.

In terms of durability and operational conditions, the FJ Series is designed to function in a wide temperature range, from -20° C to +60° C, making it suitable for use in extreme environments.

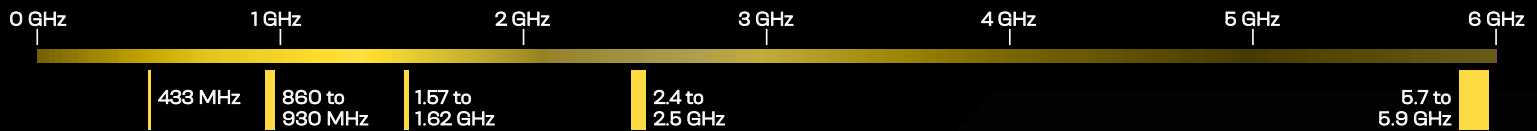

## FJ360

FJ360-2      FJ360-4

<b>Typ. Range</b>	▶ 3 km	3 km
<b>Sectors</b>	▶ 2 (180°)	4 (360°)
<b>Total output</b>	180 W	360 W
<b>Directional 2.4 to 2.5 GHz</b>	▶ 25 W	25 W
<b>Directional 1.57 to 1.62 GHz</b>	▶ 40 W	40 W
<b>Directional 5.7 to 5.9 GHz</b>	▶ 20 W	20 W
<b>Omnidirectional 433 MHz</b>	▶ 20 W	20 W
<b>Omnidirectional 860 to 930 MHz</b>	▶ -	-
<b>Colors</b>	▶ RAL	RAL

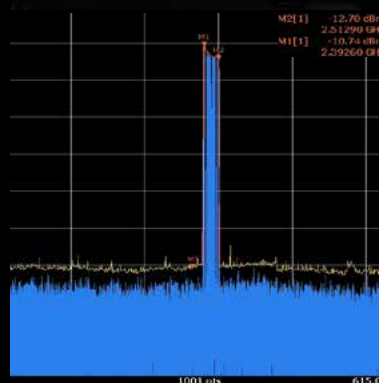

2.4 GHz signal purity

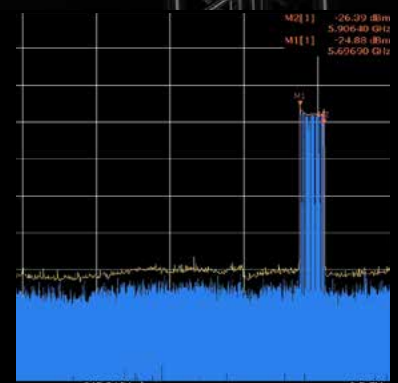

5.8 GHz signal purity



The MJ40 handheld UAV jammer is a potent and portable drone jamming system, featuring a 40W output power and an impressive 2 km range. Covering four frequency bands, it ensures adaptability to diverse unmanned aerial vehicles.

With a two-hour battery life, the device provides a reliable and portable solution for countering potential drone threats. It features the highest coverage among commercial models, making it a valuable tool for security and defense applications. Moreover, the device is customizable on demand, allowing users to tailor its specifications for specific operational needs, enhancing its flexibility and utility.

The MJ170 compact 6-band jammer is a versatile countermeasure system offering flexible mounting options such as tripod, truss, or vehicle installations. Covering six customizable frequency bands, it provides a broad spectrum of interference capabilities tailored to diverse threats. The MJ170 supports either an exchangeable battery for on-the-go operations or external power supply options for extended usage. The jammer ensures reliable performance in adverse environments, making it suitable for diverse outdoor settings.

This compact 6-band jammer stands as a comprehensive and adaptable solution for countering a wide range of potential threats.



MJ40

MJ170

	MJ40	MJ170
<b>Usage</b>	Handheld	Tripod mount
<b>Typ. Range</b>	2 km	4 km
<b>Total output</b>	40 W	170 W
<b>Directional 2.4 to 2.5 GHz</b>	2x10 W	25 W
<b>Directional 1.57 to 1.62 GHz</b>	10 W	30 W
<b>Directional 5.7 to 5.9 GHz</b>	10 W	30 W
<b>Directional 865 to 930 MHz</b>	10 W (optional)	30 W
<b>Directional 5.2 MHz</b>	-	30 W
<b>Directional 1170 to 1300 MHz</b>	-	25W
<b>Battery life</b>	Up to 2h	Up to 1.5h
<b>Operating Temperature</b>	-20°C to +60°C	-20°C to +60°C
<b>Dimensions in mm</b>	353 x 260 x 131	387 x 282 x 160
<b>Weight in kg</b>	~2.700 g	~7.000 g
<b>Colors</b>	black, white, olive, sand	black, white, olive, sand



For detailed specifications of our products please visit [www.aartos-dds.com](http://www.aartos-dds.com) or use the dedicated QR-Code:



AARTOS™ Overview

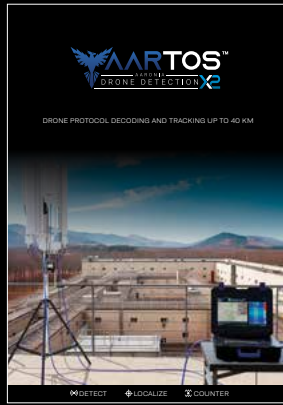

AARTOS™ X2

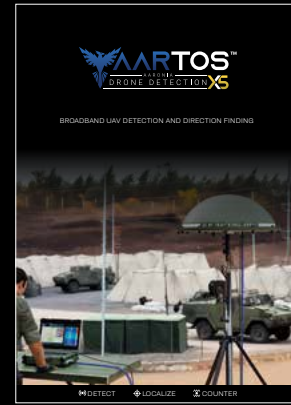

AARTOS™ X5

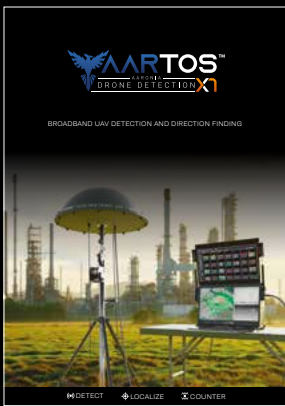

AARTOS™ X7



AARTOS™ X9



AARTOS™ Counter UAV Systems

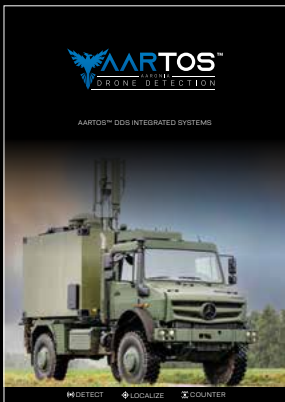

AARTOS™ System Integrations



AARTOS™ Catalog

